

"NO WIGGLE" CABINET PULLOUT ORGANIZERS



What makes a great "No Wiggle" pullout?

Self-indexing rear bracket

225 lb slide for strength and stability

2 adjustable shelves

Concealed soft-close slides included

UV Coated White Birch

Adjustable front mounting bracket eliminates excessive wiggle

Integrated, 6-way adjustable, door mounting brackets

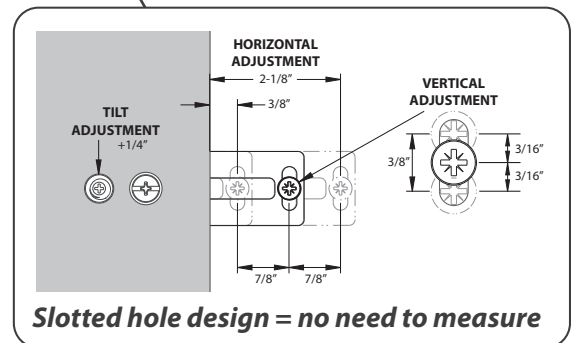

How do we eliminate the common side-to-side movement – what we call wiggle – found in pullouts?

We designed our pullout to be secured to the cabinet with a heavy-duty top slide and an adjustable side-mounting bracket, so it works in either face frame or frameless applications. The rear back bracket adds an additional secure point. The bottom-mount concealed soft-close slides are attached to a mounting brace, which also functions as a built-in jig, meaning no need to measure, just pull it flush with the back of the face frame. Our "No Wiggle" technology is unique to Hardware Resources and protected under US Patents 9,661,924; 9,723,922; 10,251,480 & 10,028,581.

"No Wiggle" Base Pullout



Ships Fully Assembled

Scan to watch the installation video
<http://delivr.com/22TZY>



Patented* top mounting bracket eliminates excessive side-to-side movement and sag, yet is hidden under the first shelf for a clean look

Bottom slides are concealed undermount slides, and the top slide is rated for 225 lb adding support and weight bearing capacity

Patented* integrated 6-way adjustable door-mounting brackets allow for easy mounting of door

Two fixed shelves and two adjustable shelves included

Frameless Friendly! Works in both face frame and frameless applications

Ships fully assembled (with slides already attached) for a significant savings in installation time

*US Patents 9,661,924 & 9,723,922 & 10,028,581 & 10,251,480



! Requires full height door

	Width	Depth	Height	Min. Opening	Standard Cabinet Size	Ctn Qty
BPO2-5SC	5-1/2"	22"	24"	6"	9" base	1
BPO2-8SC	8-1/2"	22"	24"	9"	12" base	1
BPO2-11SC	11-1/2"	22"	24"	12"	15" base	1
BPO2-14SC	14-1/2"	22"	24"	15"	18" base	1

Recommended screw:

#8 flat head

hardware resources®

800.463.0660
www.HardwareResources.com

"No Wiggle" Drawer Base Pullout



Fits below a drawer!

Shorter height fits below drawer

Built on our "No Wiggle" platform

Patented* top mounting bracket eliminates excessive side-to-side movement and sag, yet is hidden under the first shelf for a clean look

Bottom slides are concealed undermount slides, and the top is a 225 lb slide for added support and weight bearing

Patented*, integrated, 6-way adjustable, door-mounting brackets allow for easy mounting of door

Two fixed shelves and one adjustable shelf included

Frameless Friendly! Works in both face frame and frameless applications

Ships fully assembled (with slides already attached) for a significant savings in installation time

*US Patents 9,661,924 & 9,723,922 & 10,028,581 & 10,251,480

Ships Fully Assembled

	Width	Depth	Height	Min. Opening	Standard Cabinet Size	Ctn Qty
DBPO-5SC	5-1/2"	22"	20"	6"	9" base	1
DBPO-8SC	8-1/2"	22"	20"	9"	12" base	1

Recommended screw:

Screws included – #8 flat head

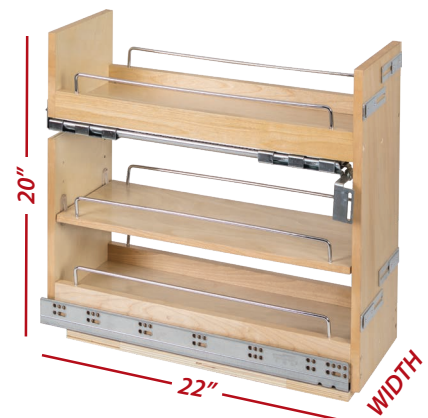

NEW! "No Wiggle" Tray Divider Pullout



**Save installation time:
Ships fully assembled
with slides pre-installed**

Built on our "No Wiggle" platform
Patented* top mounting
bracket eliminates excessive
side-to-side movement and sag

Removable center rack and
adjustable dividing bars
allow for easy and versatile
customization of storage needs

Patented*, integrated, 6-way
adjustable, door-mounting
brackets allow for easy
mounting of door

Frameless Friendly! Works in
both face frame and frameless
applications

Non-slip bottom mat keeps items
secure and minimizes noise

*US Patents 9,661,924 & 9,723,922
& 10,028,581 & 10,251,480

! Also great for foil, plastic
wrap and bag storage

**Scan to watch the
installation video**
<http://delivr.com/22TZY>

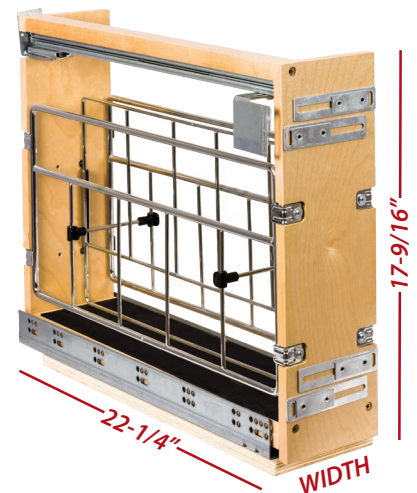

	Width	Depth	Height	Min. Opening	Standard Cabinet Size	Ctn Qty
BPOTD2-5SC NEW	5"	22-1/4"	17-9/16"	6"	9" base	1
BPOTD2-8SC NEW	8"	22-1/4"	17-9/16"	9"	12" base	1

**Recommended
screw:**

#8 flat head

**hardware
resources**

800.463.0660
www.HardwareResources.com



***"No Wiggle"
Utensil Base Pullout***

Scan to watch the
installation video
<http://delivr.com/22TZY>



(UBPO-8SC shown)

- Convenient storage of kitchen utensils
 - Included 4 stainless steel bins are easy to remove for cleaning
 - Open bottom shelf for additional storage
 - Built on our "No Wiggle" platform
 - Patented* top mounting bracket eliminates excessive side-to-side movement and sag, yet is hidden under the first shelf for a clean look
 - Concealed soft-close undermount slides
 - Patented*, integrated, 6-way adjustable, door-mounting brackets allow for easy mounting of door
 - Frameless Friendly! Works in both face frame and frameless applications
 - Ships fully assembled (with slides already attached) for a significant savings in installation time
- *US Patents 9,661,924 & 9,723,922 & 10,028,581 & 10,251,480

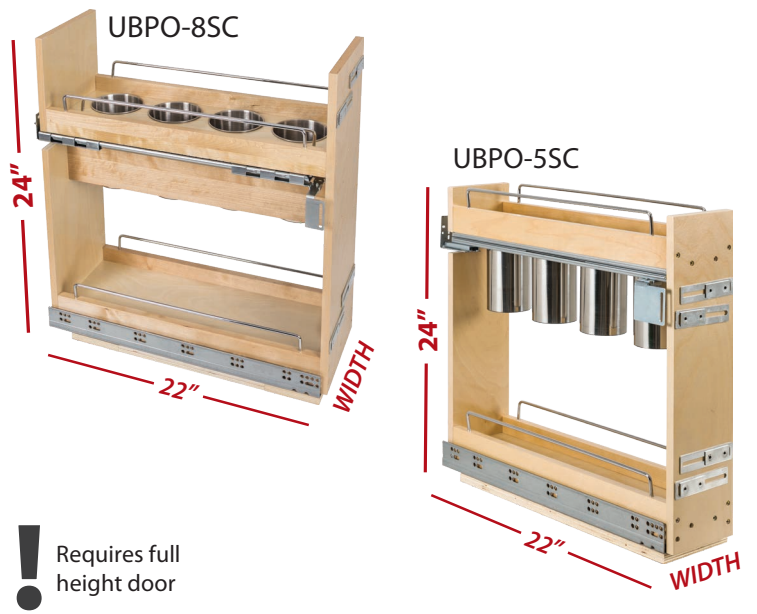

! Requires full height door

	Width	Depth	Height	Min. Opening	Standard Cabinet Size	Ctn Qty
UBPO-5SC NEW	5-1/2"	22"	24"	6"	9" base	1
UBPO-8SC	8-1/2"	22"	24"	9"	12" base	1

Recommended screw: screws included – #8 flat head

NEW! "No Wiggle" Base Filler Pullout



Used in 3" and 6" wide base cabinet applications

Installs in dead space between base cabinets

Built on our "No Wiggle" platform

Patented* top mounting bracket eliminates excessive side-to-side movement and sag, yet is hidden under the first shelf for a clean look

Patented*, integrated, 6-way adjustable, door-mounting brackets allow for easy mounting of door

Two fixed shelves and two adjustable shelves included

Frameless Friendly! Works in both face frame and frameless applications

Ships fully assembled (with slides already attached) for a significant savings in installation time

*US Patents 9,661,924 & 9,723,922 & 10,028,581 & 10,251,480

Ships Fully Assembled



BFPO2-6SC

	Width	Depth	Height	Ctn Qty
BFPO2-3SC NEW	3-1/2"	23"	30"	1
BFPO2-6SC NEW	6-1/2"	23"	30"	1
Recommended screw:		#6 face frame		



BFPO2-3SC

hardware
resources®

800.463.0660

www.HardwareResources.com

NEW! "No Wiggle" Wall Pullout



Ships Fully Assembled

- Built on our "No Wiggle" platform
 - Patented* top mounting bracket eliminates excessive side-to-side movement and sag, yet is hidden under the first shelf for a clean look
 - Bottom slides are concealed undermount slides, and the top is a 100 lb slide for added support and weight bearing
 - Patented*, integrated, 6-way adjustable, door-mounting brackets allow for easy mounting of door
 - Two fixed shelves and two adjustable shelves included
 - Frameless Friendly! Works in both face frame and frameless applications
 - Ships fully assembled (with slides already attached) for a significant savings in installation time
- *US Patents 9,661,924 & 9,723,922 & 10,028,581 & 10,251,480

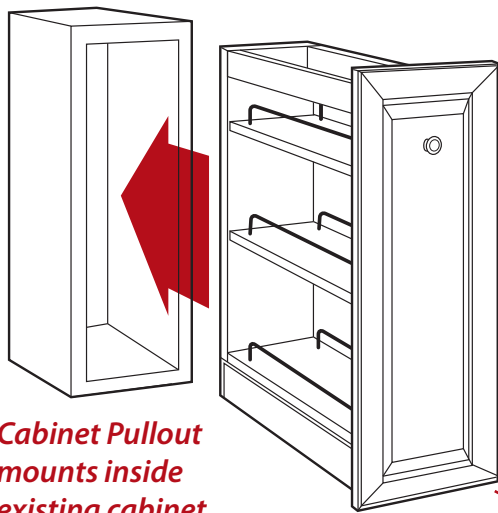

Cabinet Pullout mounts inside existing cabinet

door front not included

Scan to watch the installation video
<http://delivr.com/22TZY>



	Width	Depth	Height	Min. Opening	Standard Cabinet Size	Ctn Qty
WPO2-5SC NEW	5-7/16"	11-5/16"	24"	6"	9" wall	1
WPO2-8SC NEW	8-7/16"	11-5/16"	24"	9"	12" wall	1

Recommended screw: #8 flat head

"No Wiggle" Vanity Base Pullout



Shown with Grooming Organizer Insert (sold separately)

- Shortened height and depth designed to fit into bathroom vanity cabinets
 - Built on our "No Wiggle" platform
 - Patented* hardware eliminates excess side-to-side movement
 - Modular design allows for the use of optional grooming organizer or acrylic tray
 - Smooth soft-close slides
 - Adjustable dividers included in top shelf
 - Patented*, 6-way adjustable, door mounting brackets allow for easy mounting of doors
 - Two fixed shelves and one adjustable shelf included
 - Ships fully assembled (with slides already attached) for a significant savings in installation time
- *US Patents 9,661,924 & 9,723,922 & 10,028,581 & 10,251,480

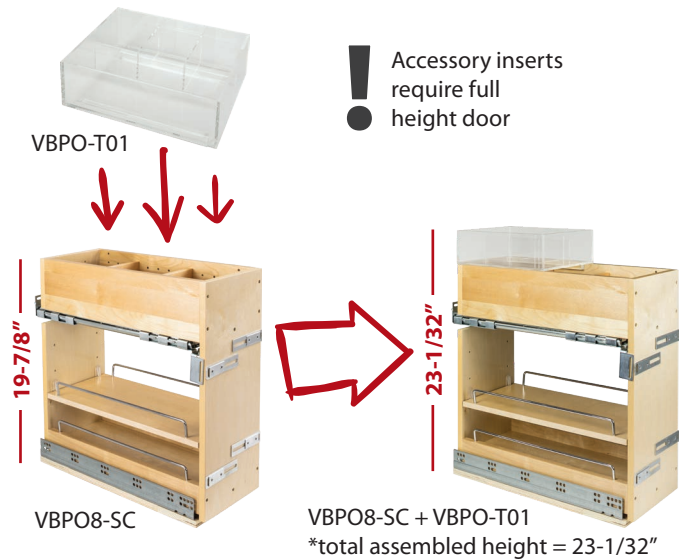
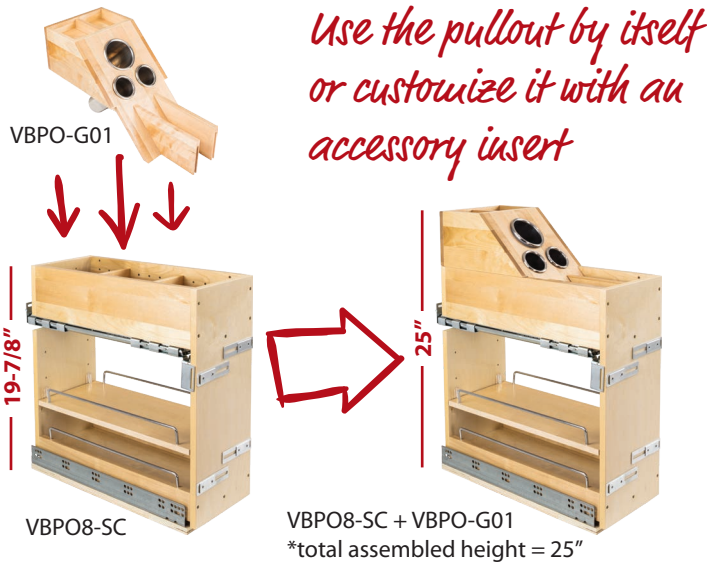

	Description	Width	Depth	Height*	Min. Opening	Standard Cabinet Size	Ctn Qty
VBPO8-SC	8" wide "No Wiggle" vanity pullout	8-1/2"	18-13/16"	19-7/8	9"	12" base	1
VBPO-G01	Grooming organizer insert	8"	18-7/32"	9"	9"	12" base	1
VBPO-T01	Acrylic tray insert	8"	10-3/32"	3-7/16"	9"	12" base	1

Recommended screw:

Screws included – #8 flat head

*Total assembled height of Vanity Base Pullout with inserts is listed above

hardware
resources®

800.463.0660
www.HardwareResources.com

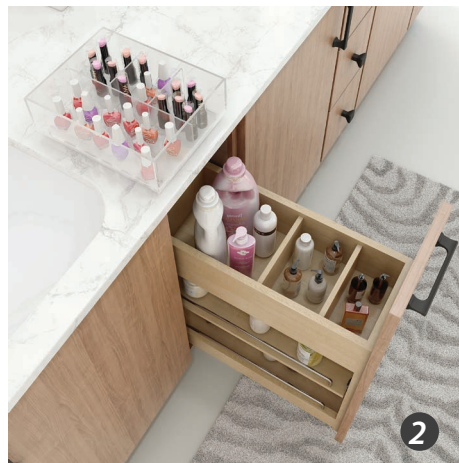

TAME BATH CLUTTER:

Vanity base pullouts are great for narrow bathroom cabinets. Made of high quality wood and built on our superior "No Wiggle" platform, these pullouts are designed to keep clutter at bay.

1. The base pullout features fixed top and bottom shelves and one adjustable middle shelf. Middle and bottom shelves feature chrome rails to keep items secure. Optional top insert accessories maximize storage.
2. The acrylic tray insert is perfect for nail polish, makeup or other small items. And it's removable, so it can be set on the countertop for even easier access.
3. Use the Grooming Insert to store hair dryers, curling irons and other hair appliances.

STORAGE with STYLE®

Storage solutions that beautifully coordinate to create a harmonious kitchen design



Drawer Base Pullout



Base Pullout



Utensil Base Pullout

Features the "No Wiggle" patented* hardware that eliminates excessive sag and side-to-side movement



Design is in the details

Curved flat wire design details flow across all organizers to create a cohesive collection identity

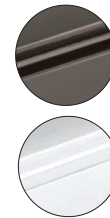

Stylish finish options

Designer finishes of Black Nickel and Polished Chrome coordinate with popular hardware styles, or mix finishes to add variety

hardware
resources®

800.463.0660 | www.HardwareResources.com



To view the entire collection of Storage with Style® products, scan the QR code or visit: <http://delivr.com/2uppy-qr>

*US Patents 9,661,924, 9,723,922, 10,251,480 & 10,028,581